



**Juno**

Catalog Number
Notes
Type

FRONT PORCH, SCREEN PORCH, SIDE DOOR, BACK DOOR OFF GARAGE, REAR PORCH.

Contractor Select™  
**WF4 & WF6 REG**  
**SWW5**

4" & 6" LED Regressed Switchable Downlight

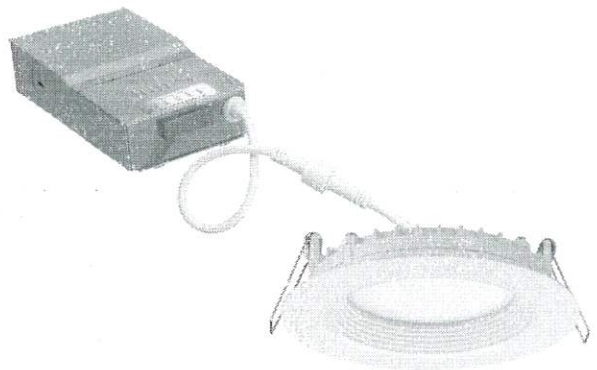

The 4" and 6" regressed round baffle with 5CCT Switchable White technology provides high-quality light output and efficiency featuring a switch for easy color temperature adjustment to choose between 2700K, 3000K, 3500K, 4000K, or 5000K while eliminating the need for recessed housings.

**FEATURES:**

- Regressed lens and baffle trim designed to distribute precise even illumination for general purpose areas
- Canless – no can required; equals easy to install and less labor
- 5 selectable color temperatures to choose with a switch ranging from warm (2700K) to daylight (5000K) allowing customization for endless applications



Catalog Number	UPC	Description	Replaces Up To	Lumens	Input Watts	CCT	CRI	Voltage	Finish	Dimming Protocol	Pallet qty.
WF4 REG SWW5 90CRI MW M6	194994158523	4" Regressed Baffle LED Downlight	65W Incandescent	650	9W	2700K/3000K/3500K/4000K/5000k	90	120V	Matte White	Triac	480
WF6 REG SWW5 90CRI MW M6	194994158660	6" Regressed Baffle LED Downlight	75W Incandescent	950	13W	2700K/3000K/3500K/4000K/5000k	90	120V	Matte White	Triac	360

**Accessories: Order as separate catalog number.**

WF8643 PAN R6	Universal New Construction Pan, Retail Pack of 6
WF8643 PAN U	Universal New Construction Pan, unit pack
WF4 PAN R12	4" new construction pan, retail pack of 12
WF6 PAN R12	6" new construction pan, retail pack of 12
WF4GR MW	4" Wafer Goof Ring 4.2" ID x 6.2" OD
WF6 PAN R12	6" New construction pan, retail pack of 12
WF6GR MW JZ	6" Wafer Goof Ring 6" ID x 8" OD
WFJB U	Remodel Joist Bar
WFEXC6 SW3PIN FT4	3-Pin 6ft Cable
WFEXC10 SW3PIN FT4	3-Pin 10ft Cable
WFEXC20 SW3PIN FT4	3-Pin 20ft Cable



\*Goof rings are made of 22 gauge steel and painted white.



## Specifications

### HOUSING:

Die cast aluminum mounting frame with integral polycarbonate flange provides passive thermal cooling achieving L70 at 50,000 hours. Non-conductive dead-front trim design suitable for a wide range of applications and codes requiring a non-conductive • Lens regressed to .5" with baffle trim design to reduce glare for comfortable and even illumination • Non-conductive dead-front trim design suitable for a wide range of applications and codes requiring a non-conductive lens • FT4 3-pin plenum rated cable connector to connect from module to remote driver box • Steel spring clip for easy installation. 4" & 6" cut out templates are provided to ensure a correct sized hole is cut into ceiling for proper installation of the trim. Size of hole should not exceed 4 1/4 inches for the WF4 and 6 1/4 for the WF6 • Can be installed from 3/8" to 1 1/2" ceiling thickness • Can be removed from below the ceiling for service or replacement.

### LED LIGHT ENGINE:

LEDs are integrated to one piece high purity aluminum, thermally conductive housing to provide uninterrupted heat transfer to ensure long life of the LED Switchable white color temperature from 2700K, 3000K, 3500K, 4000K, 5000K • 90 CRI minimum • Color accuracy within 4 step MacAdams Ellipse at the end CCT (2700K and 5000K), within 6 step MacAdams Ellipse in the middle CCT (3000K, 3500K, and 4000K) • Dimming 100% to 10% with most standard incandescent dimmers ([see list of approved dimmers](#)).

### DRIVER:

Connect directly to 120V Class-2 (CAN ICES-005 (B) / NMB-005 (B)) LED driver. 120V 60 Hz constant current driver provides noise free operation • IC rated driver with convenience of a switch to choose between 5 selectable color temperature options ranging from 2700K (warm white), 3000K, 3500K, 4000K, or 5000K (daylight) • The isolated driver integrated inside steel remote box with four 7/8" knockouts with slots for pryout. Suitable for pulling wires with the 12 cubic-inch wiring compartment to accommodate up to (6) 14 gauge insulated conductor or (4) 12 gauge insulated conductors; making the Wafer LED Downlights much easier to wire in 2in/2out (plus ground) daisy-chain applications and contractor friendly • 2" plenum space required for installation of the remote driver box • Suitable for installation in t-grid and drop ceiling applications with universal new construction pan.

### OPTICAL SYSTEM:

Edge-lit LED technology uses light guided plate to distribute light • Polycarbonate lens provides even illumination throughout the space • Efficient system that can produce over 650 lumens while using 9W with the WF4 and over 970 lumens while using 13W with the WF6 • Replaces 65W incandescent (WF4) and 75W incandescent (WF6).

### LIFE:

Rated for 50,000 hours at 70% lumen maintenance.

### LABELS:

CSA certified to US and Canadian safety standards • ENERGY STAR® certified product • Suitable for wet location, covered ceiling • Air-Loc certified in accordance with ASTM E283-2004 • NOM Certified • Can be used to comply with California Title 24 Part 6 High Efficacy LED light Source Requirements • U.S. Patent No. 10,681,784.

### TESTING:

All reports are based on published industry procedures; field performance may differ from laboratory performance.

### WARRANTY:

5-year limited warranty. This is the only warranty provided and no other statements in this specification sheet create any warranty of any kind. All other express and implied warranties are disclaimed. Complete warranty terms located at: [www.acuitybrands.com/support/warranty/terms-and-conditions](http://www.acuitybrands.com/support/warranty/terms-and-conditions)

**Note:** Actual performance may differ as a result of end-user environment and application. All values are design or typical values, measured under laboratory conditions at 25 °C. Specifications subject to change without notice.

## Dimensions

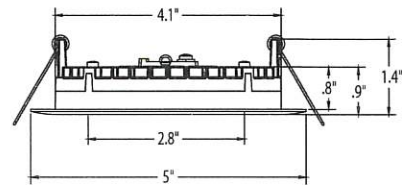

WF4

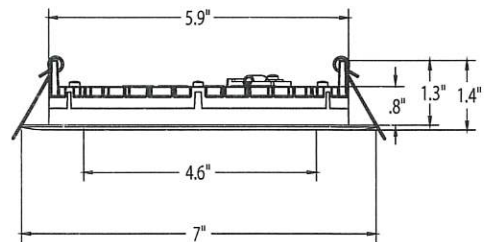

WF6

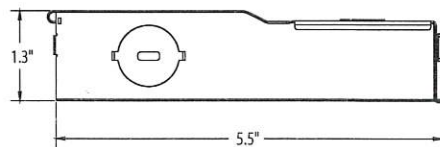
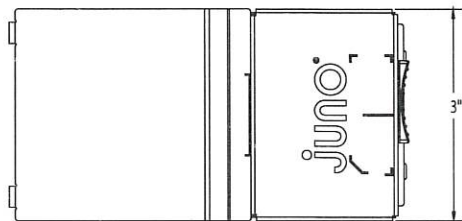

## PERFORMANCE DATA

	WF4 SSW5	WF6 SSW5
Input Voltage	120V	120V
Input Power Typical	9W (+/-5%)	13W (+/-5%)
Frequency	60 Hz	60 Hz
EMI/RFI	FCC Title 47, Part 15 Class B (consumer)	FCC Title 47, Part 15 Class B (consumer)
Minimum Starting Temp	-40°F (-40°C)	-40°F (-40°C)

Note: Actual performance may differ as a result of end-user environment and application. All values are design or typical values, measured under laboratory conditions at 25°C.

SCREEN PORCH CEILING FAN  
NO LIGHT.



# Altus Flush

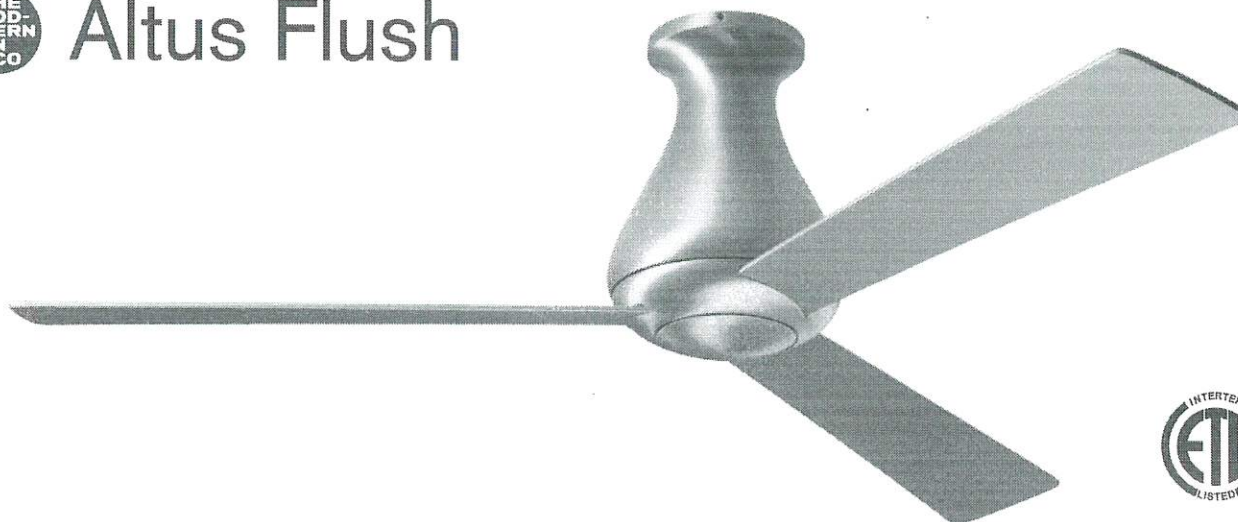

Altus Flush > Configure item number from attributes below.

Finish	Blade Span	Blade Color	Light Option	Control Option
#ALT-FM -	-	-	-	-
▲ <b>GW</b> Gloss White	▲ <b>52</b> 52" Span	▲ <b>WH</b> White	▲ <b>NL</b> No Light	▲ <b>001</b> Fan Speed Only
<b>BA</b> Brushed Aluminum	<b>42</b> 42" Span	<b>AL</b> Aluminum	<b>271</b> 17W LED	<b>002</b> Fan & Light - 3 Wire
				<b>003</b> Handheld Remote
				<b>004</b> Fan & Light - 2 Wire
				<b>005</b> Wall/Remote Combo

## Dimensions

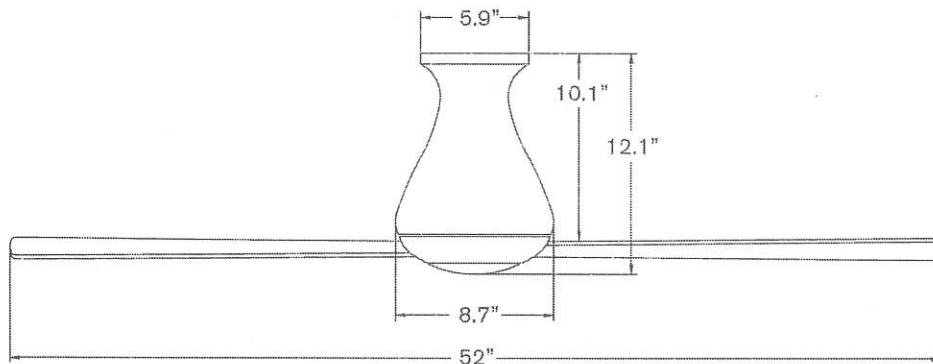

Also available in 42" blade span.

## Specifications

- 153mm x 18mm AC motor with reverse switch on fan body
- Die cast aluminum construction
- 42" or 52" span, plywood blades
- Optional LED light: 17W, 90-CRI, 3000K, 1530 lumens (dimnable) behind an opal glass diffuser; adds 1.5" to length of fan; CA Title 24, JAB-2019 compliant
- For flat ceilings only
- Designed by Ron Rezek
- ETL listed for dry and damp locations
- Weight: 15 lbs (6.8 kgs)

## Performance Data

### LOWEST SPEED

**RPM:** 70  
**CFM:** 1,425  
**Watts:** 10.9  
**CFM/W:** 131

### HIGHEST SPEED

**RPM:** 225  
**CFM:** 4,879  
**Watts:** 68.82  
**CFM/W:** 71

## Energy Guide Data

**Average Energy Use**  
42 Watts

**Average Airflow**  
3,260 CFM

**Yearly Energy Cost**  
\$12

**Average Efficiency**  
77 CFM/Watt

\* Performance and Energy Guide Data corresponds to the 52" blade span. For 42" Performance and Energy Guide data, visit [www.modernfan.com](http://www.modernfan.com).

\*\* Energy Guide Data represents weighted averages of low speed and high speed performance, assuming typical use (excluding light). For more information, visit [www.modernfan.com](http://www.modernfan.com).

SPEC SHEET

Linear Lantern Short  
Item # CHO 29588Z

Designer: Chapman & Myers

Height: 15"  
Width: 9"  
Extension: 5"  
Backplate: 9" x 13" Rectangle  
Finishes: AB, AN, BZ, PN, WZ  
Glass Options: CG  
Socket: 2 - E12 Candelabra  
Wattage: 2 - 60 W  
©EFC DESIGNS

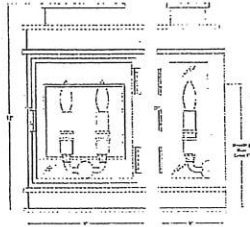
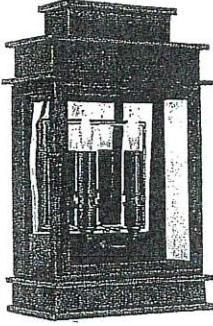

DETACHED GARAGE  
WALL LIGHT OVER DOORS  
BRONZE  
2 - 40 WATT S BULBS